

Top View

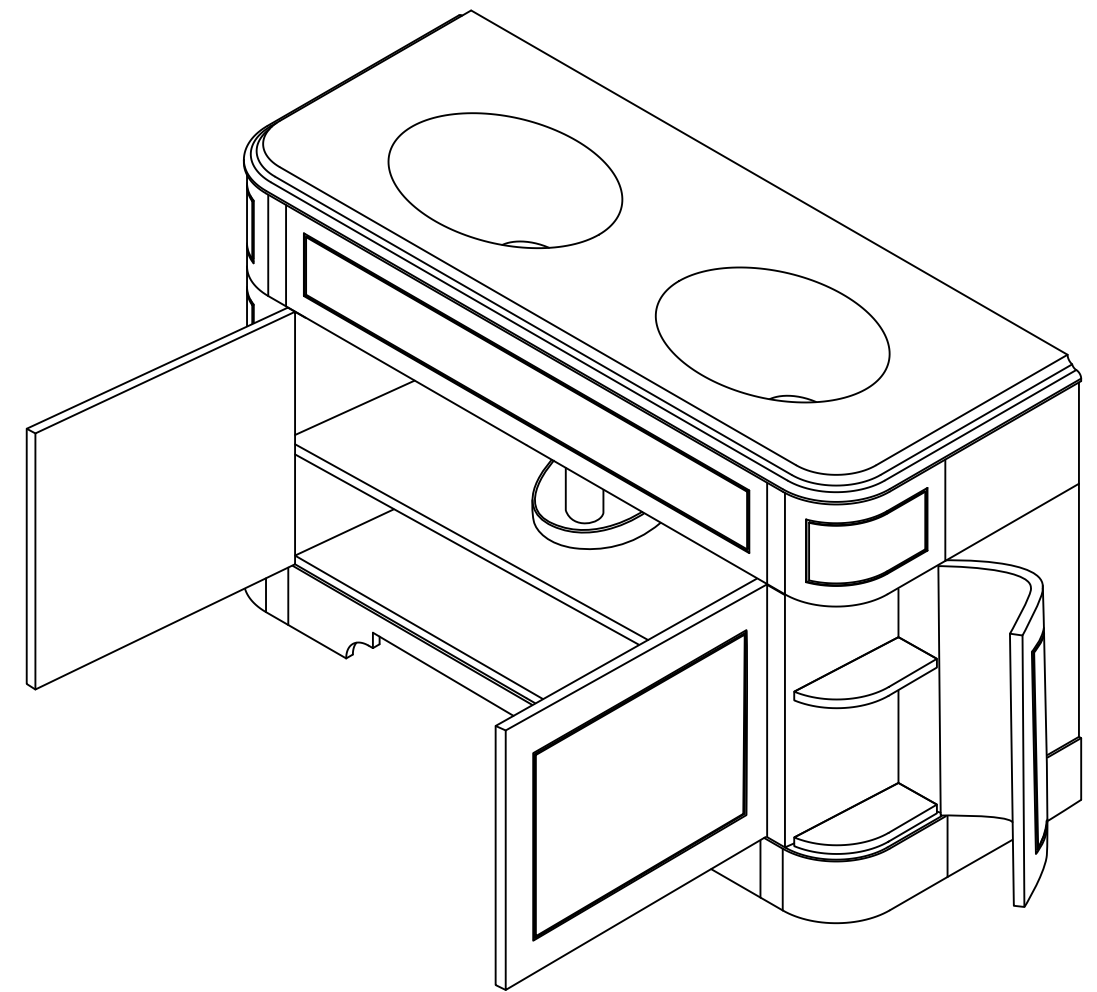

Front View

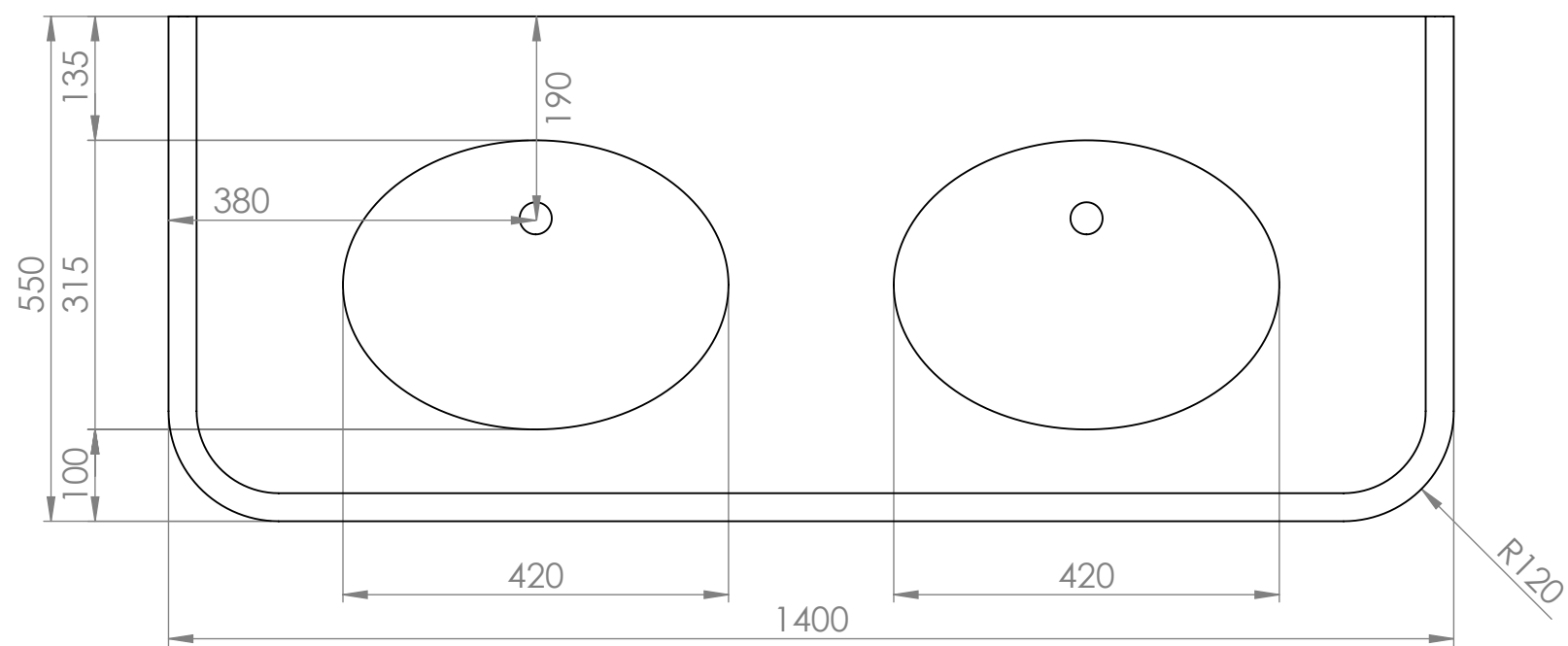
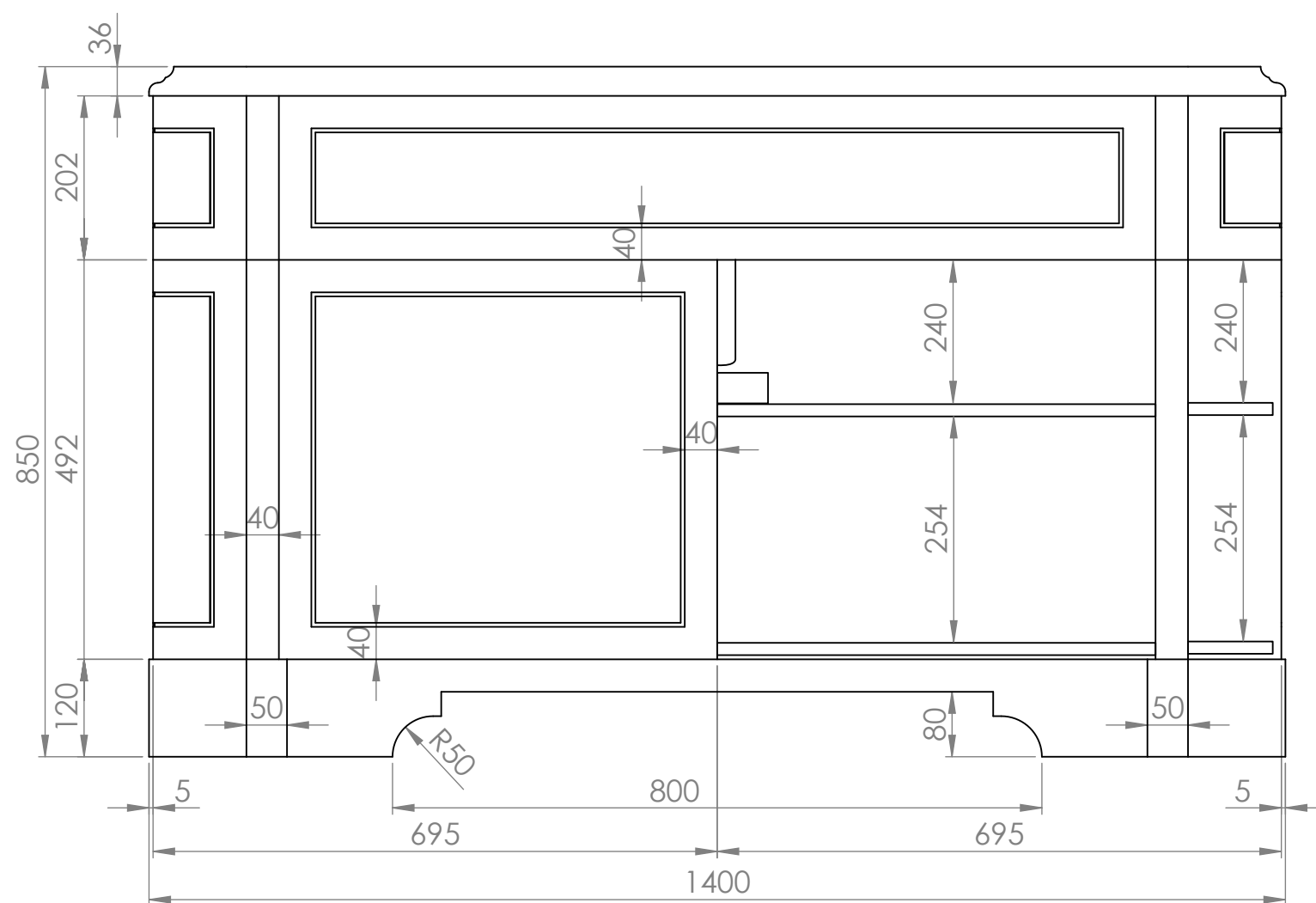

Side View

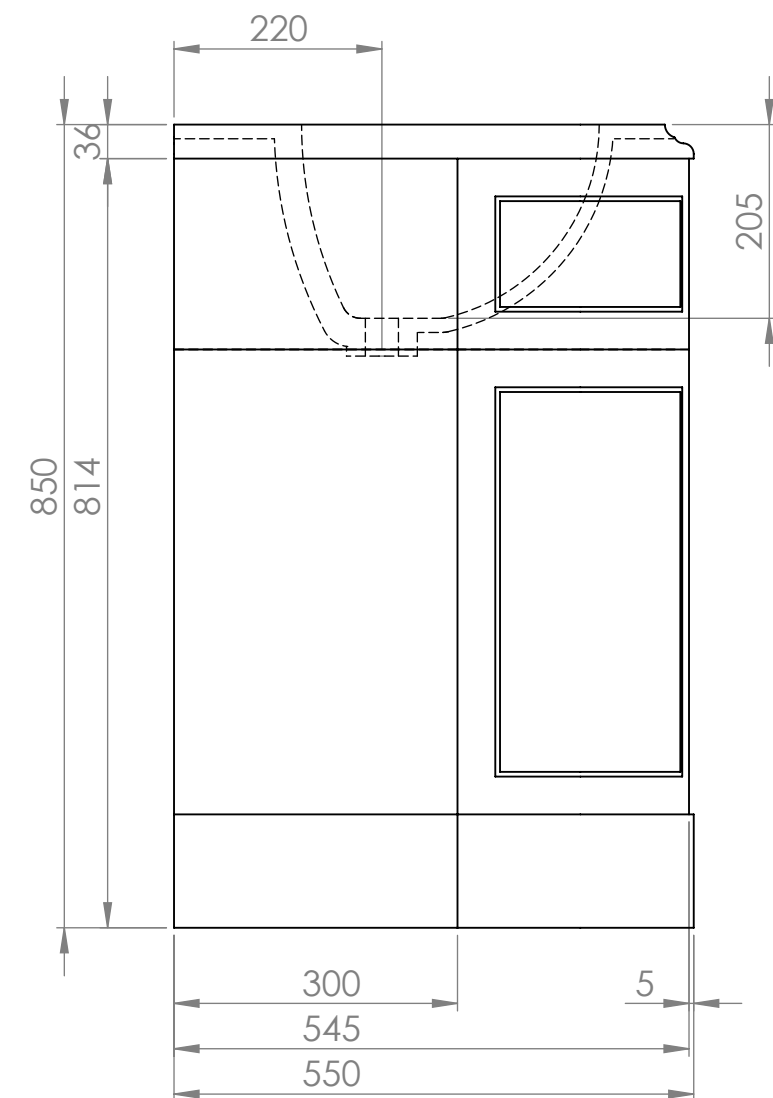

LUSO

Product Name

Connaught

Size, mm

1400 x 550 x 850

All dimensions provided in millimeters.

All vanity units are supplied with no tap hole (s). If you require a tap hole, you will need to use a standard 38mm hole-saw drill attachment.