

Side View - Section View

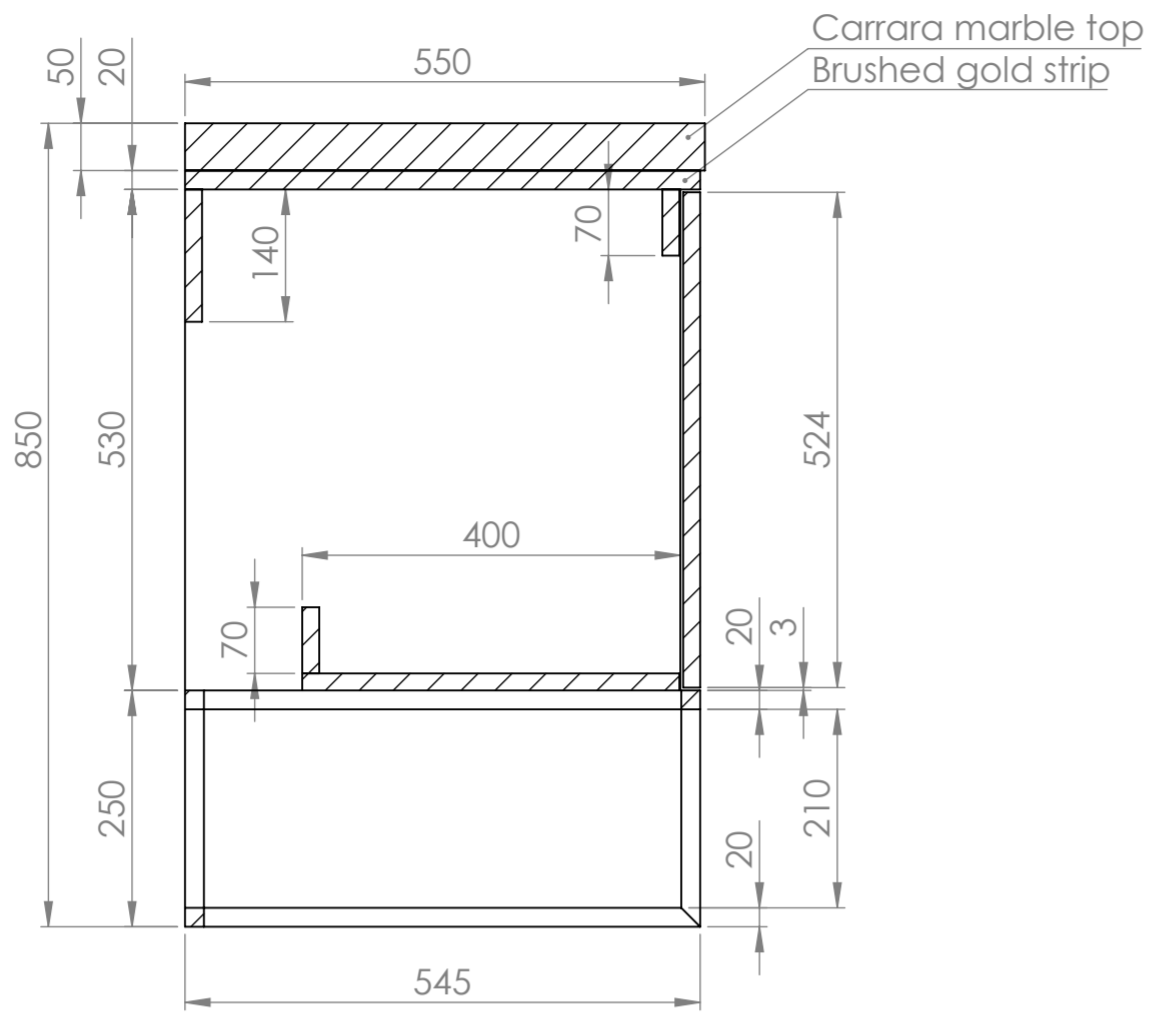

Front View

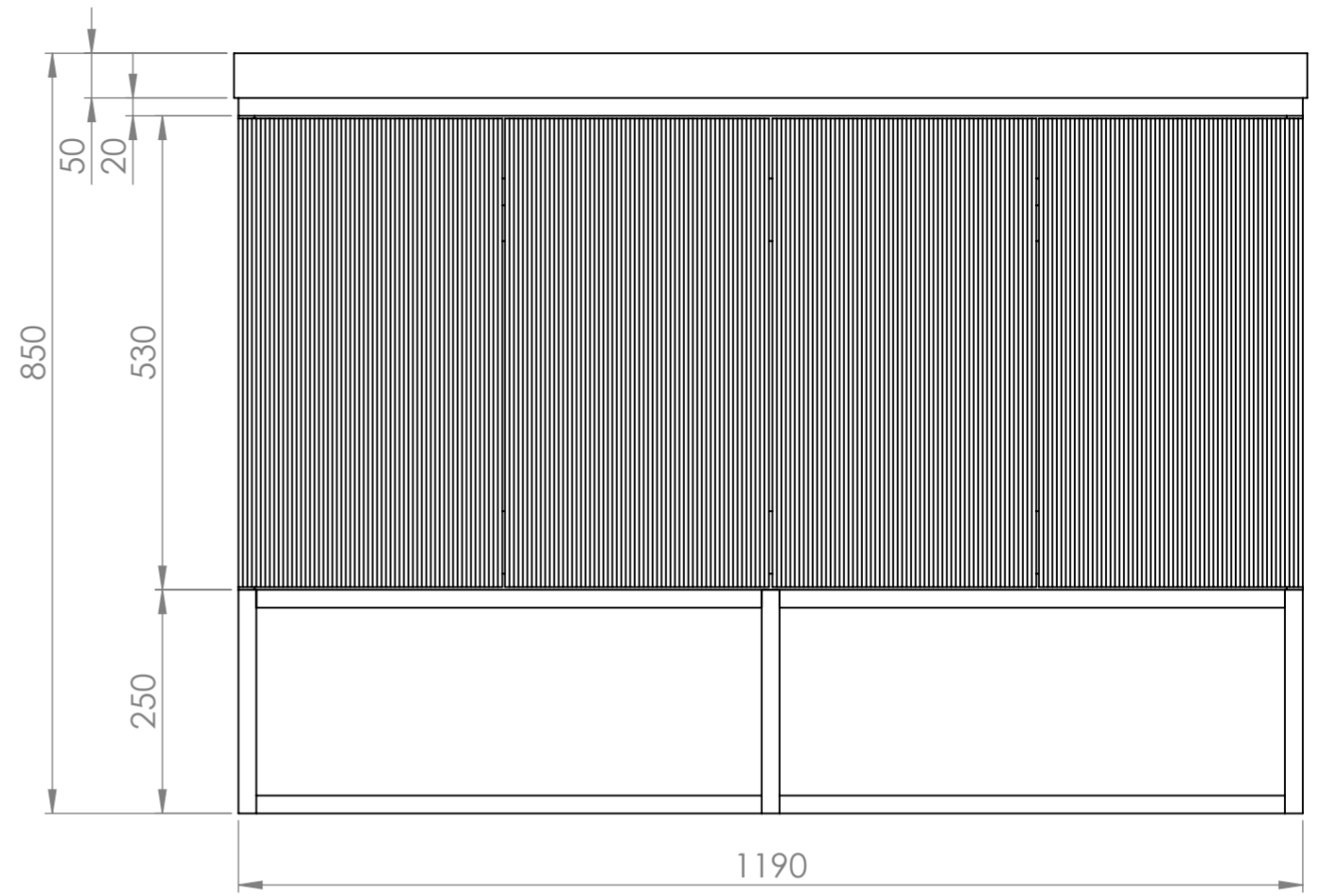

Top View

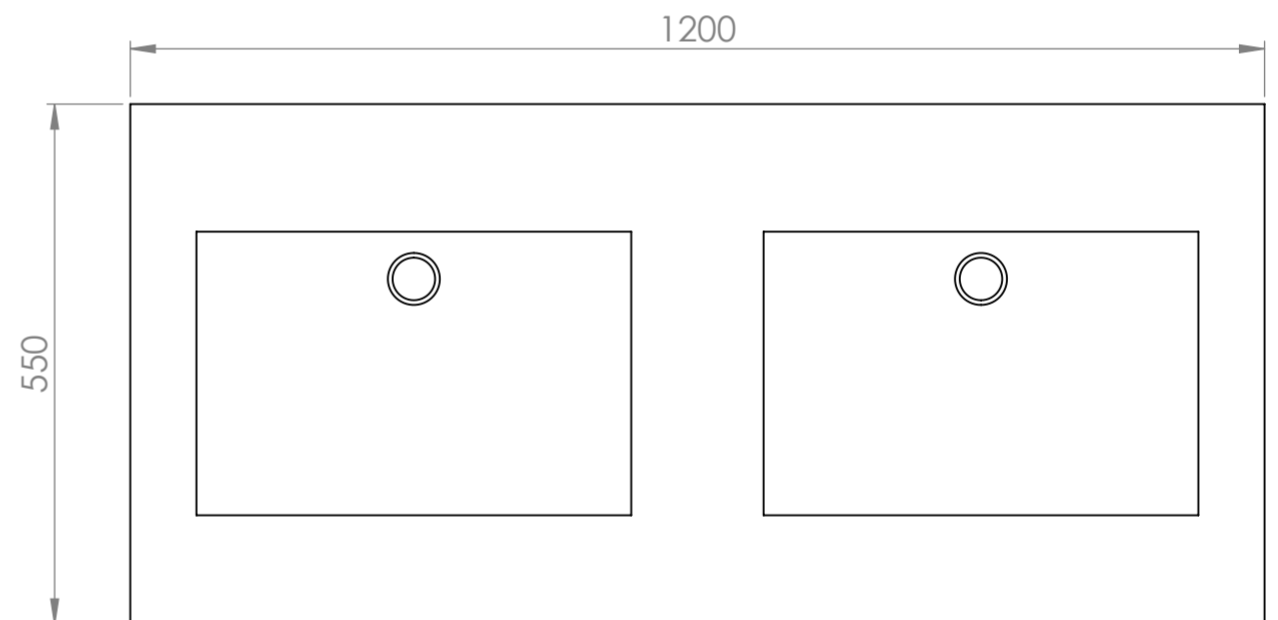

Top View - Section View

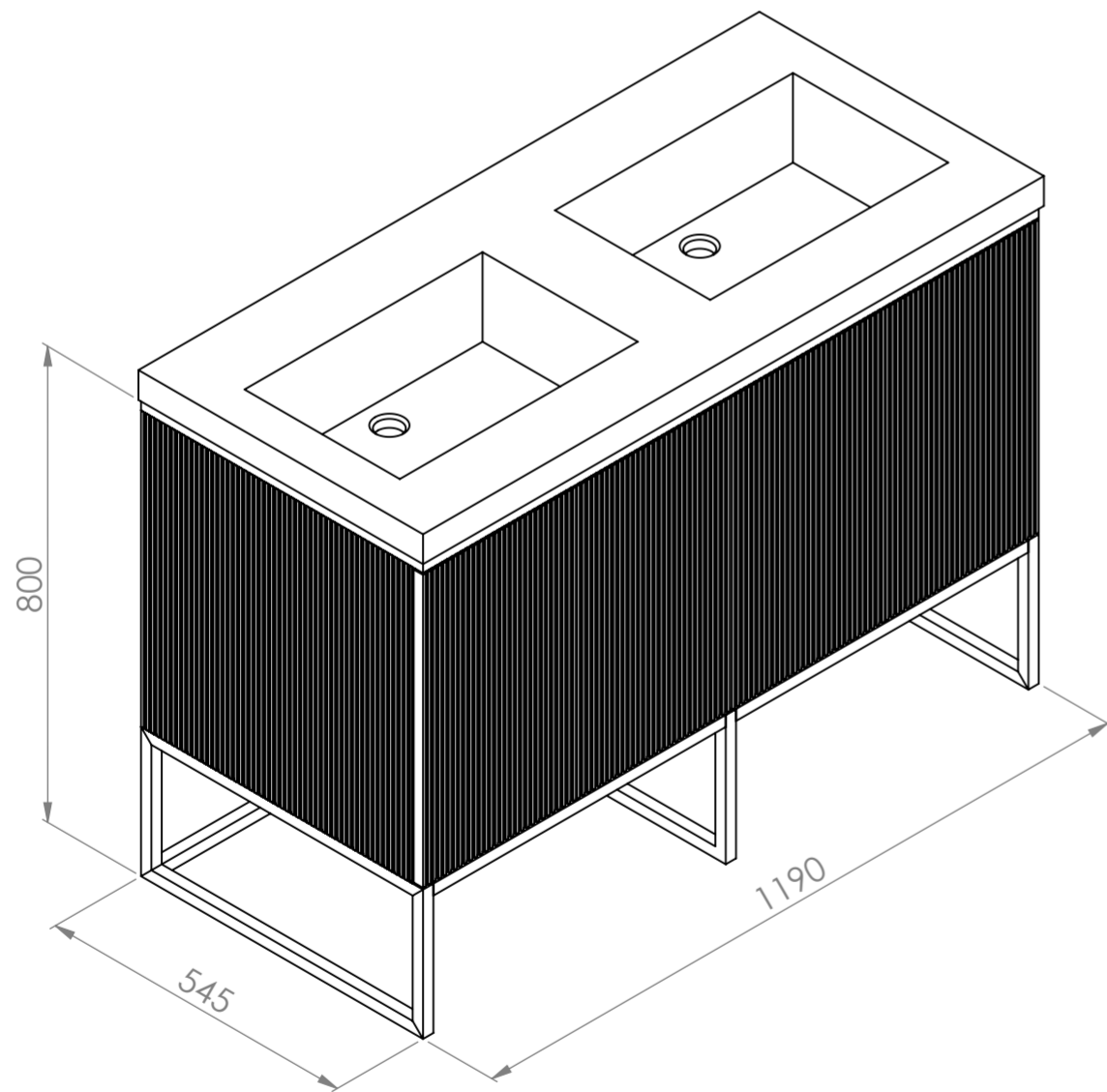
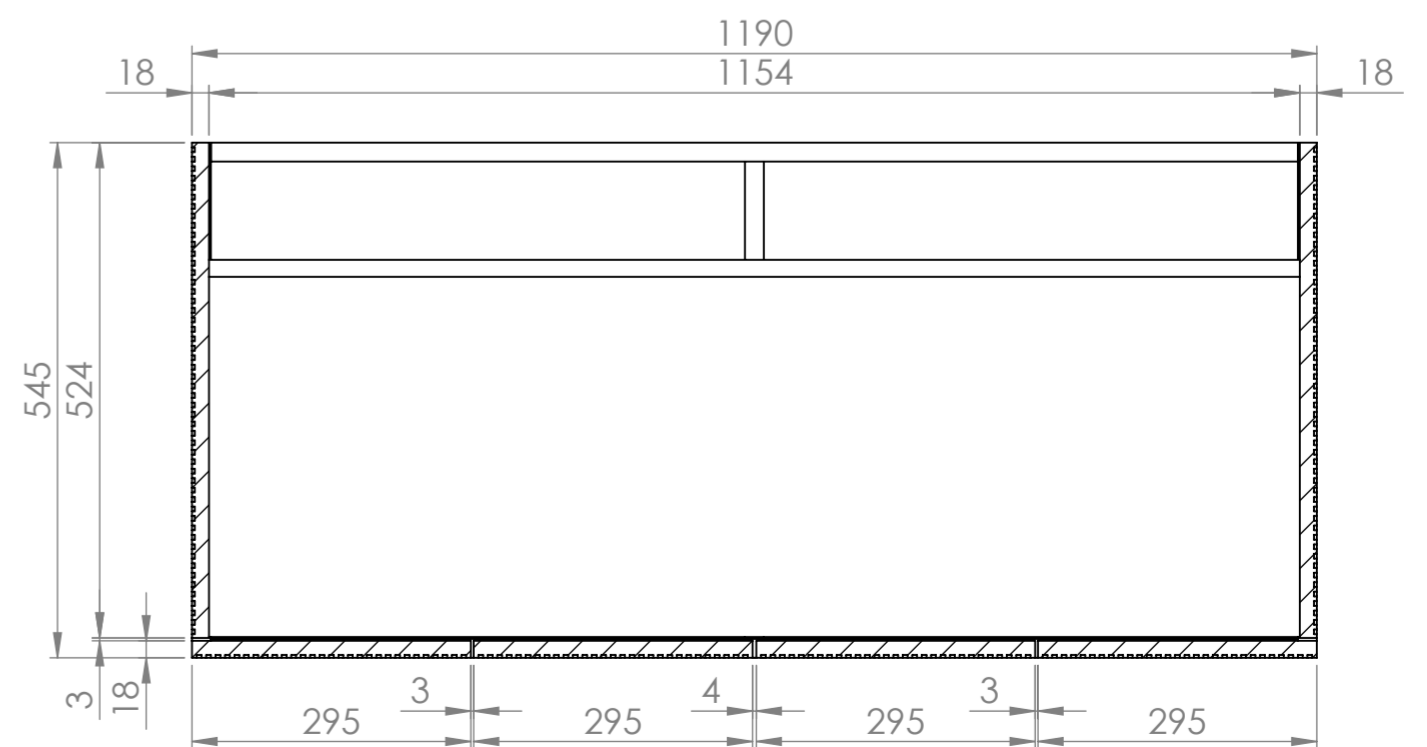

LUSO

Product Name	Couture 1200
Size, mm	1200 x 545 x 790

All dimensions provided in millimeters.
All vanity units are supplied with no tap hole (s). If you require a tap hole, you will need to use a standard 38mm hole-saw drill attachment.