

Shelf 1200

Assembly Instructions

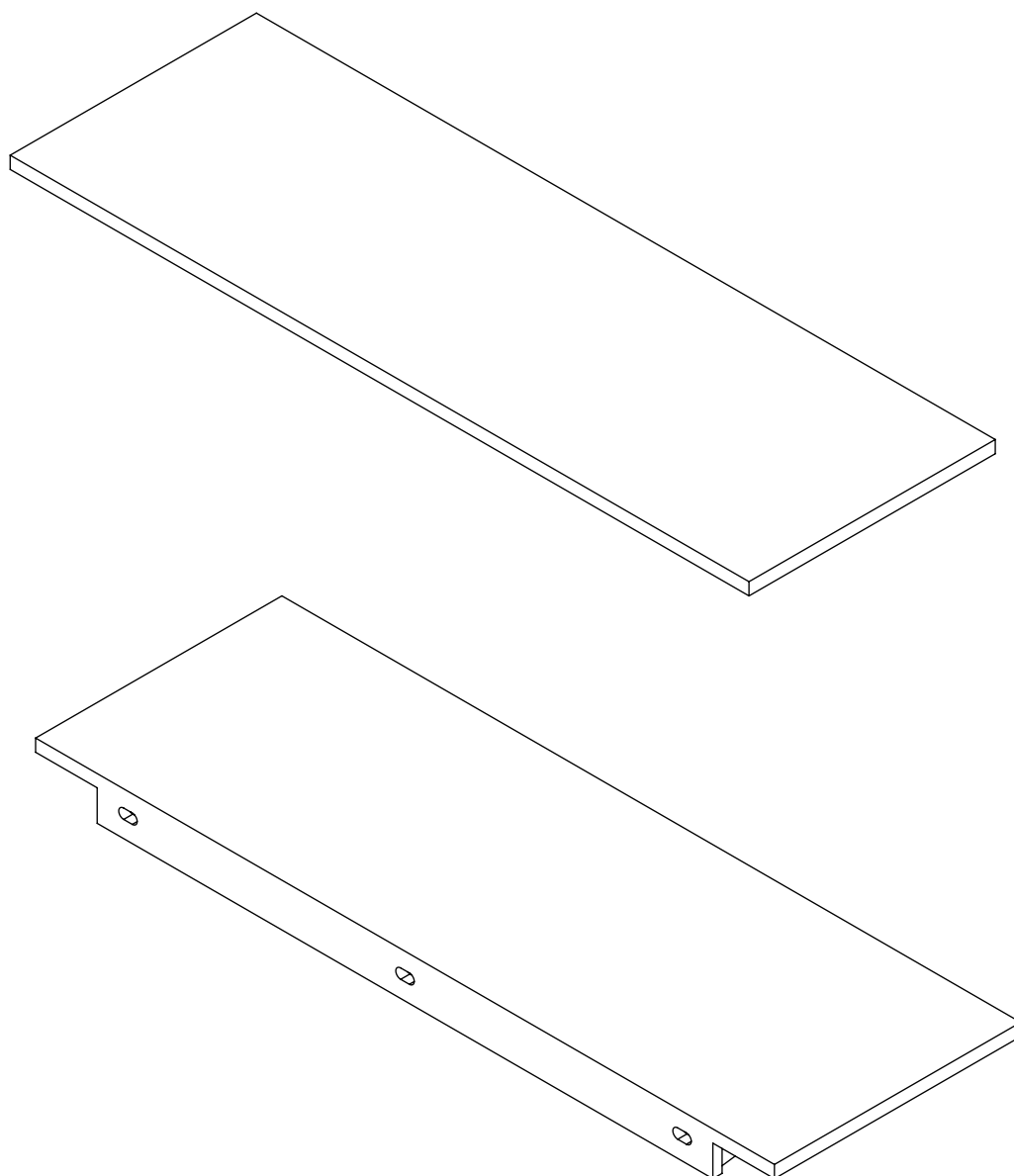

LUSO
S T O N E

Components

LUSSO
S T O N E

Bolt

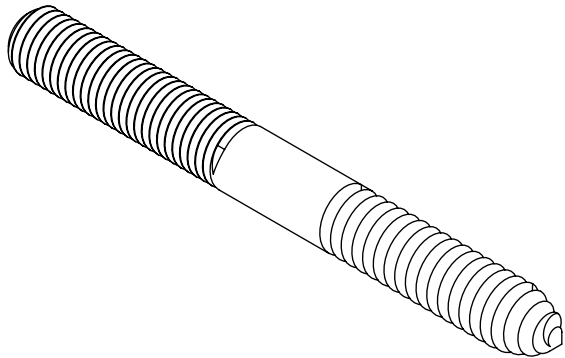

Amount: 3

Nut

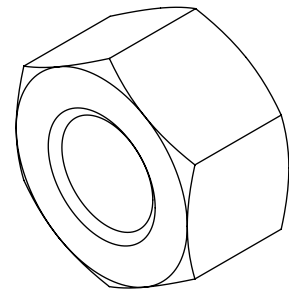

Amount: 3

Plastic Grommet

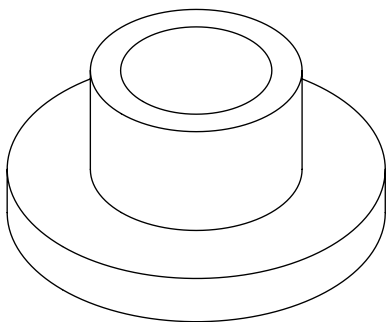

Amount: 3

Metal Washer

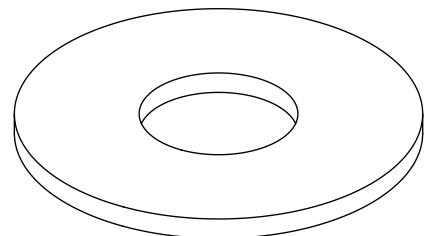

Amount: 3

<1>

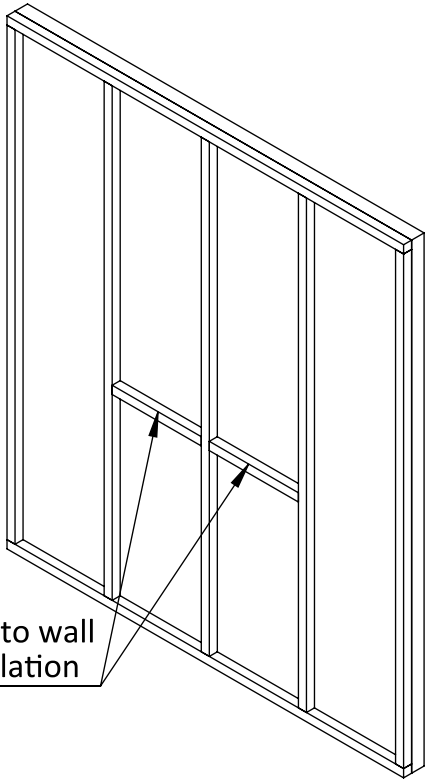

Add battens to wall before installation

<2>

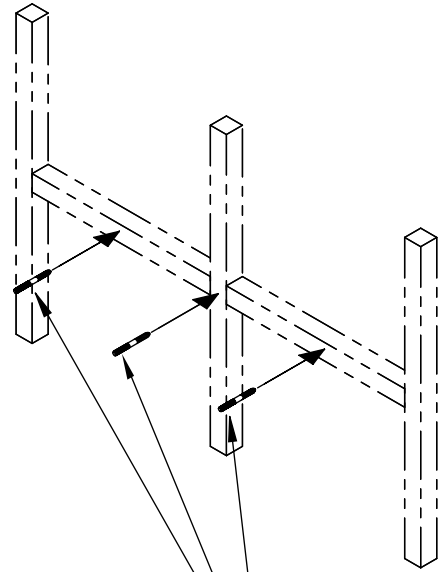

Add bolts to plasterboard

Note: Product can be mounted on both concrete or timber-framed walls.

<3>

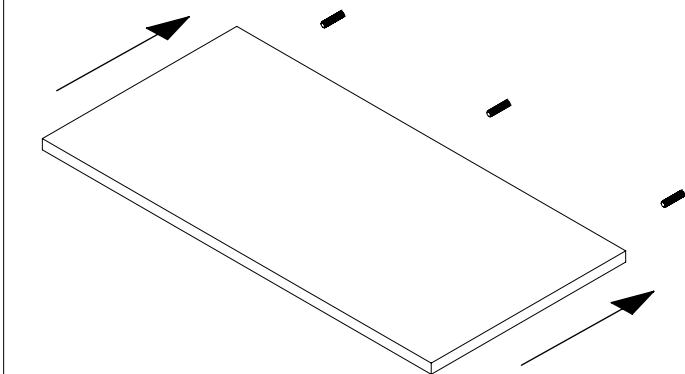

<4>

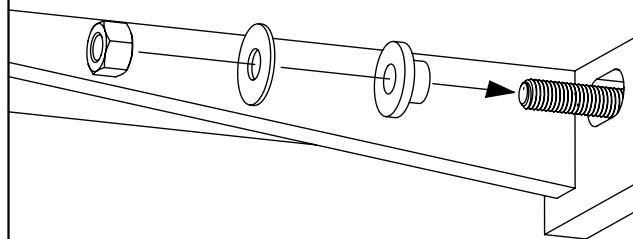

LUSSO
S T O N E

Assembly Complete

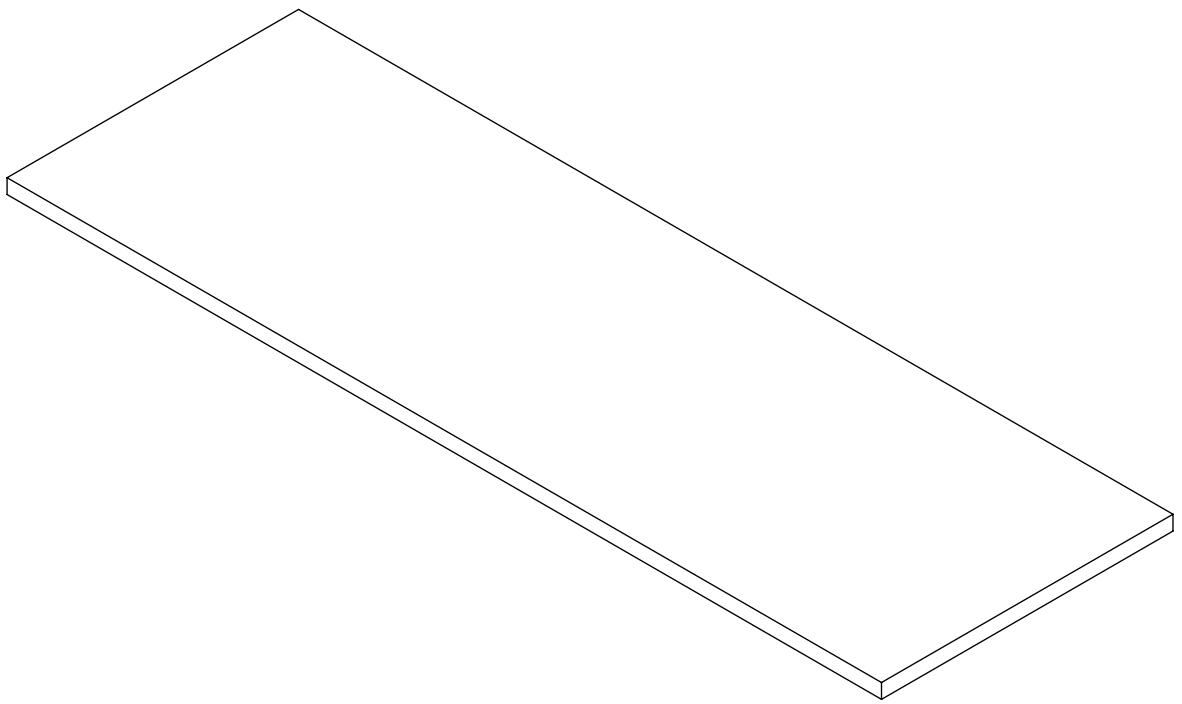

LUSSO
S T O N E

Holes for basin waste and tap can be added using standard hand drill and a hole cutting tool.

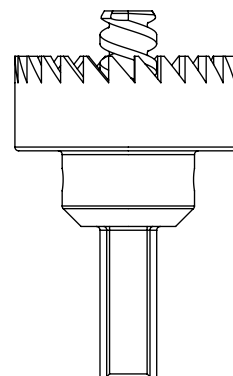
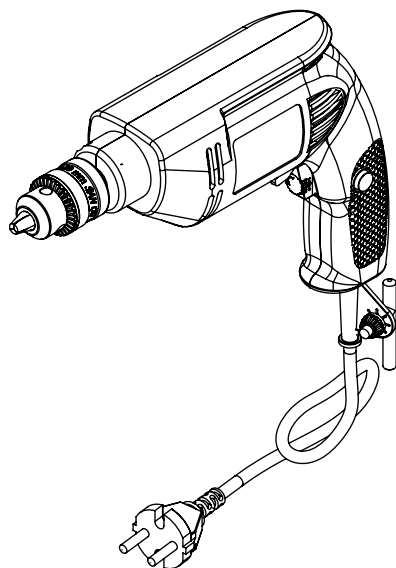

Recomended Hole Cutting Tool Sizes

44 mm tool for
basin waste hole

38 mm tool
for tap hole

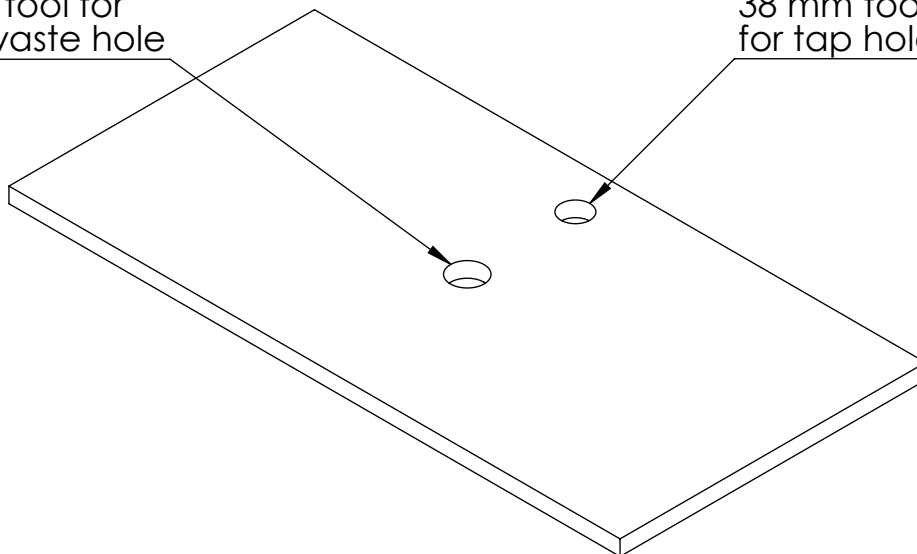

LUSSO
S T O N E